

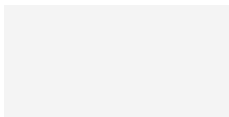







/ Vision

Colores / Colours / Couleurs / Farben

	Blanco RAL 9003 /		Antracita RAL 7016 /		Moka NCS S4010 /
	Zinc NCS S4502 /		Arena NCS S3005 /		Taupe NCS S6005 /
	Gris RAL 7030 /		Crema RAL 9001 /		Chocolate RAL 8017 /

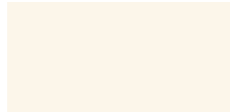
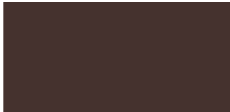
 Colores personalizables bajo carta RAL de colores / Customizable colours according to RAL chart / Couleurs personnalisables selon nuancier RAL / Personalisierbare Farben nach RAL-Karte

Texturas / Texture / Texture / Oberfläche

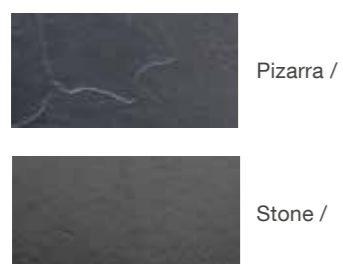

Colocación / Installation / Positionnement / Einbau

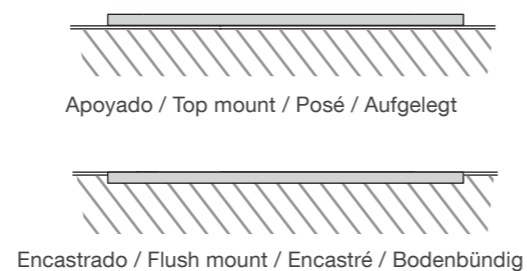

Formato / Size / Dimensions / Format

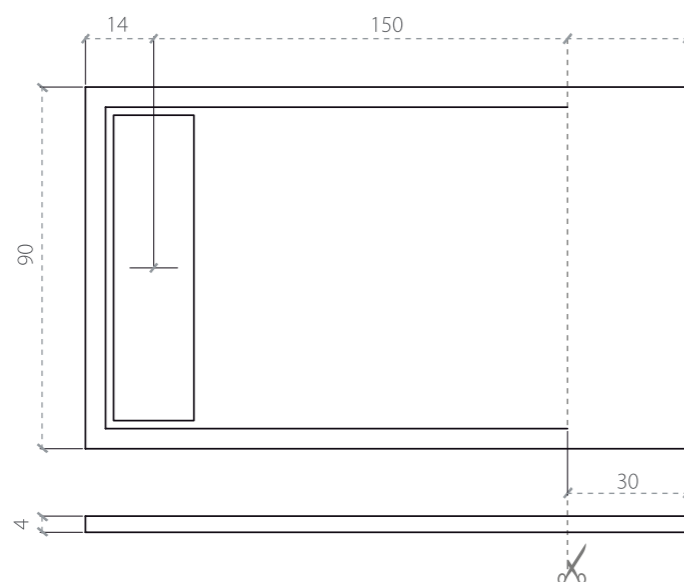

 Corte personalizado / Custom cut / Coupe personnalisée / Maßzuschnitt

Pesos / Weights / Poids / Gewicht

Dim. cm	
90x150	125 Kg

